

### Features

- High Luminous LEDs
- 4.8mm Straw Standard Directivity
- Superior Weather-resistance
- UV Resistant Epoxy
- Water Clear Type

### Applications

- Electronic Signs And Signals
- Small Area Illuminations
- Back Lighting
- Other Lighting

### Outline Dimension

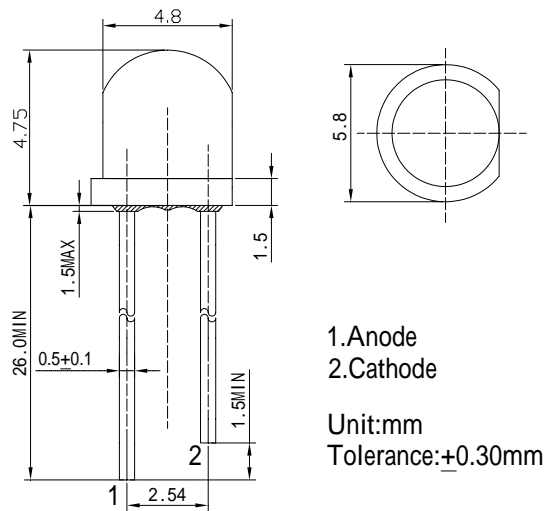

### Absolute Maximum Rating

( $T_a=25^\circ\text{C}$ )

Item	Symbol	Value	Unit
DC Forward Current	$I_F$	30	mA
Pulse Forward Current*	$I_{FP}$	100	mA
Reverse Voltage	$V_R$	5	V
Power Dissipation	$P_D$	72	mW
Operating Temperature	$T_{opr}$	-30 ~ +85	
Storage Temperature	$T_{stg}$	-40 ~ +100	
Lead Soldering Temperature	$T_{sol}$	260 /5sec	-

\*Pulse width Max.10ms Duty ratio max 1/10

### Directivity

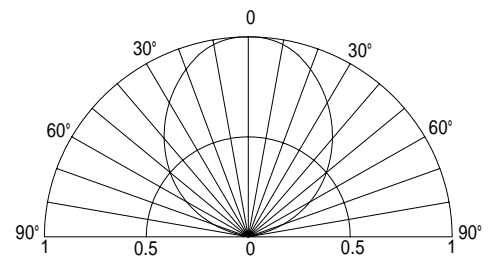

### Electrical -Optical Characteristics

( $T_a=25^\circ\text{C}$ )

Item	Symbol	Condition	Min.	Typ.	Max.	Unit
DC Forward Voltage	$V_F$	$I_F=20\text{mA}$	1.8	2.1	2.4	V
DC Reverse Current	$I_R$	$V_R=5\text{V}$	-	-	10	$\mu\text{A}$
Domi. Wavelength*	$\lambda_D$	$I_F=20\text{mA}$	585	590	595	nm
Luminous Intensity*	$I_v$	$I_F=20\text{mA}$	-	600	-	mcd
50% Power Angle	$2\theta_{1/2}$	$I_F=20\text{mA}$	-	100	-	deg

\*1 Tolerance of dominant wavelength is  $\pm 1\text{nm}$

\*2 Tolerance of luminous intensity is  $\pm 15\%$